

D148W
D148S

Dishwasher user manual

imagine the possibilities

Thank you for purchasing this Samsung
product. To receive more complete service,
please register your product at

www.samsung.com/global/register

SAMSUNG

1/ FOR THE USER'S ATTENTION	
• Safety instructions _____	4
• Protection of the environment _____	5
• Economical, environmentally friendly washing _____	5
2/ DESCRIPTION OF YOUR APPLIANCE	
• General presentation of the dishwasher _____	6
• Presentation of the control panel _____	7
3/ INFORMATION _____	8
4/ WHAT TO DO BEFORE FIRST USING THE MACHINE	
• Measure the water hardness and select the type of detergent ____	9
• Hardness table _____	9
5/ DETERGENT PRODUCTS AND ADJUSTING THE WATER SOFTENER	
• For traditional products _____	10
• For multi-purpose products _____	11
6/ LOADING OF REGENERATING SALT _____	12
7/ LOADING OF RINSING PRODUCT _____	13
8/ YOUR DISHWASHER'S EQUIPMENT	
• The lower basket _____	14
• The upper basket _____	15
• The cutlery basket _____	16
9/ YOUR DISHWASHER'S SAFETY SYSTEMS _____	17
10/ WASHING PROGRAMMES TABLE _____	18
11/ PROGRAMMING _____	20
12/ CLEANING YOUR APPLIANCE	
• Cleaning the waste filters _____	22
13/ IF OPERATING ABNORMALITIES OCCUR _____	23
14/ AFTER-SALES SERVICE _____	28
15/ INDICATIONS FOR THE TESTING LABORATORIES _____	29

 **Important :** *Keep this user's manual with your appliance. If the appliance is sold or transferred to someone else, ensure that the manual is with it. Please take note of these instructions before installing and using your appliance. They have been drawn up for your own and other people's safety.*

• SAFETY INSTRUCTIONS

• Installation

- When you receive your appliance, unpack it or have it unpacked immediately. Check that it has not suffered any damage during transport. Express any reservations in writing on the delivery note, of which you keep a copy. Never connect up a damaged machine. If your appliance is damaged, please contact your dealer.
- Before proceeding to connect up your machine, please refer to the instructions in your Installation Guide.
- Your dishwasher must be kept disconnected from the mains supply throughout the whole of the installation process.
- The electrical connection details on your appliance's description plate must comply with those for the mains supply.
- The socket must still be accessible once your appliance has been installed.
- Do not alter or attempt to alter the appliance's characteristics. This could put you at risk.
- If your installation has to be altered, only entrust the electrical and plumbing work to a qualified electrician or plumber respectively.
- Your appliance is designed for normal domestic use. Do not use it for industrial or commercial purposes or for any other purpose than that for which it has been designed.
- The dishwasher's walls must not be pierced under any circumstances.

• Children's safety

- This appliance is not intended for use by young children or infirm persons unless they have been adequately supervised by a responsible person to ensure that they can use the appliance safely.
- This appliance must only be used by adults. Ensure that children do not touch it and do not use it as a toy. Ensure that they do not operate the appliance's controls.
- Keep young children away from the appliance when it is operating.
- Detergents contain irritant and abrasive substances. These products can have caustic effects on the eyes, the mouth or the throat. They can be extremely dangerous if ingested. Avoid any contact with the skin and the eyes. Ensure that the appliance's detergent container is empty at the end of the washing cycle.
- Place detergents out of children's reach and do not put any detergent in the machine until just before you start the washing programme.
- The water in your dishwasher is not drinking water; this is why children must not go near the appliance when its door is open.
- Do not let your children play or sit on the door when it is open.
- Once you have unpacked your appliance, place the packaging out of children's reach.
- Keep all the packaging materials (e.g. plastic bags, polystyrene, etc.) out of children's reach because they can be dangerous for children (ie. risk of suffocation).

• Use

- This appliance is not intended for use by persons (including children) with reduced physical, sensory or mental capabilities, or lack of experience and knowledge, unless they have been given supervision or instruction concerning use of the appliance by a person responsible for their safety.
- When machine is running, do not open door. This may provoke steam leakage or splattering of water.

- Only use products specially designed for your dishwasher (water softening salt, detergent and rinsing products).
- As far as possible, avoid opening the dishwasher's door when it is operating, and in particular during the heating phases, because scalding steam may escape or you may be splashed with hot water. The machine is fitted with a safety system that immediately blocks the dishwasher's operation if the door is opened.
- Never use chemical solvents in your appliance because these could cause an explosion.
- Always close your appliance's door after loading or removing your items.
- Do not lean or sit on your appliance's door when it is open.
- You are strongly advised to disconnect the machine after use and turn off the water supply.
- Unplug your machine before carrying out any technical work on it.
- Avoid placing your machine immediately next to a cooking or heating appliance to prevent any risk of heat damage;
- Do not place any items in your machine, which are not certified as dishwasher safe.
- If you have removed an item before the end of the washing programme, it is important to rinse it carefully to remove any residual washing products.
- If your appliance breaks down, never attempt to repair it yourself. Any repairs made by non-qualified personnel can cause significant damage or lack of control.
- The machine complies with applicable safety regulations. Any repairs should be carried out by qualified technicians. Repairs or changes that do not conform may be dangerous for the users. In case of replacement, only use original parts.
- If the machine malfunctions due to other causes than those mentioned in this booklet, disconnect the machine (remove the plug) or break the circuit concerned and contact after-sales service.

• ENVIRONMENTAL PROTECTION

This appliance's packaging material is recyclable. Help recycle it and protect the environment by dropping it off in the municipal receptacles provided for this purpose.



Your appliance also contains a great amount of recyclable material. It is marked with this label to indicate that in countries that are a members of the European Union the used appliances should not be mixed with other waste. This way, the appliance recycling organised by your manufacturer will be done under the best possible conditions, in compliance with European Directive 2002/96/EC on Waste Electrical and Electronic Equipment. Contact your town hall or your retailer for the used appliance collection points closest to your home.

We thank you doing your part to protect the environment.

• ECONOMICAL, ENVIRONMENTALLY FRIENDLY WASHING

- Remove any food residue from your crockery (bones, pips, etc.)
- Do not pre-wash your items by hand (useless waste of water).
- Utilise your dishwasher's capabilities to the full for an economical, environmentally friendly wash.
- Always select a washing programme suitable for the crockery type and how dirty they are.
- Avoid overdosing with detergent, regenerating salt and rinsing liquid. Follow the recommendations in this guide (pages 9-10-11) and the instructions on the product packs.
- Ensure that the water softener is correctly set (see pages 10).

• GENERAL PRESENTATION OF THE DISHWASHER

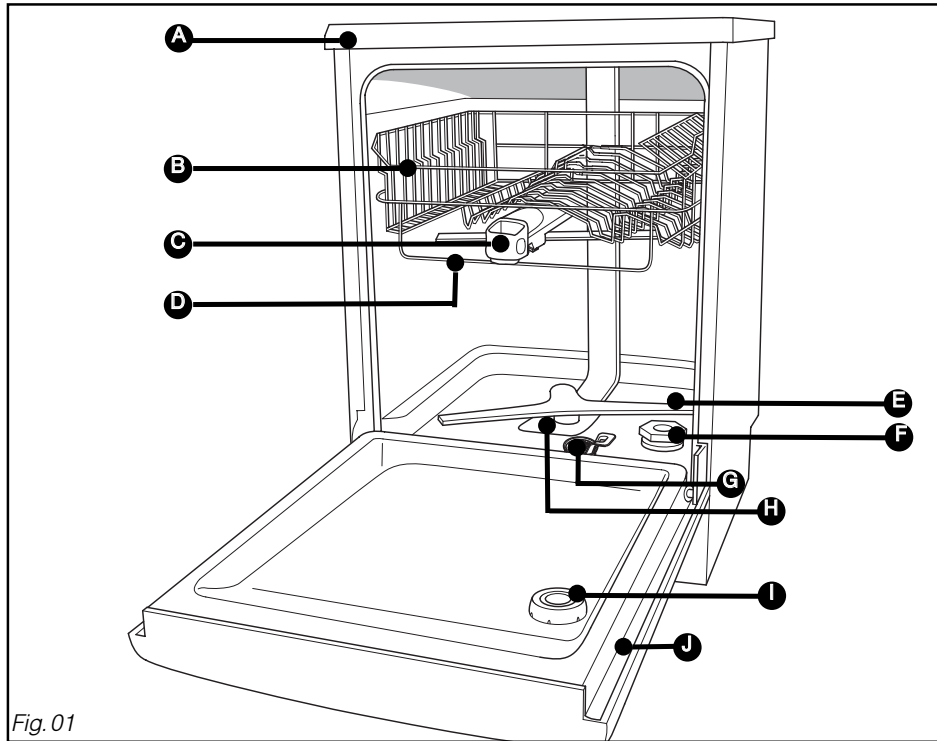

Fig. 01

- | | |
|-------------------------------------|---|
| A Removable top | F Regenerating salt tank |
| B Upper basket | G Waste filter |
| C Washing products dispenser | H Main filter |
| D oversize plate barrier | I Rinsing product dispenser |
| E Lower sprinkler arm | J Description plate (Model number) |



Advice:

This user's guide is applicable to several models. There may be some slight differences in the details and the equipment between your appliance and the descriptions provided here.

• **PRESENTATION OF THE CONTROL PANEL**

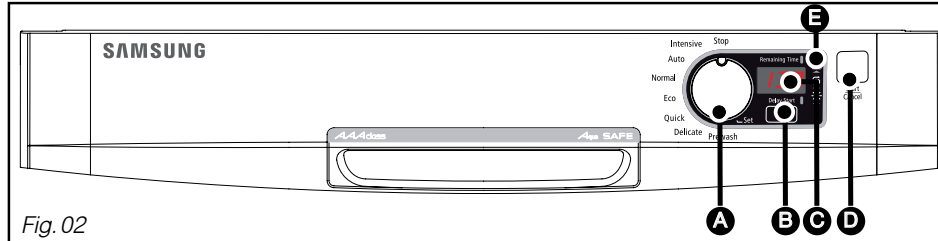

- A Selector switch (3 functions):**
- **Choosing a programme:** Turn the selector switch to choose a programme.
 - **selector switch:** Turn the switch to the Select position to access Select options. (See Section 5, / Detergent products and adjusting the water softener).
 - **Off:** Turn the switch to the "STOP" position when the programme has finished.

- B Selection of washing with a Delayed Start - Softener setting button.**

- C The Screen** gives the duration, the time remaining for the programme, the delayed start and the softener setting.

- D Start/Cancel:** Briefly press this button to start your programme. If you make an error, to cancel a selection or cancel a programme while it is running, hold down this button for 3 seconds.

- E The indicator lights:**

- Multipurpose products:** lit; shows you that the "4/1" feature is turned on and that the programmes are now automatically adjusted if a multi-function tablet is used.

- Salt:** When lit, it indicates lack of regenerating salt

- Rinsing liquid:** When lit, it indicates lack of rinsing product

**Important:**

For your dishwasher to provide impeccable washing and drying results with no marks, you must set it correctly using the water softening system, which uses regenerating salt.

- **THE WATER HARDNESS**

- **Lime:** rainwater filtering through the ground picks up mineral salts; some minerals are found in solid form commonly termed lime. This reduces the washing detergent's performance, furs up the dishwasher and leaves white marks on the crockery.

The more lime there is in the water, the more the water is called "hard".

Use the most suitable products for the level of water hardness in your town.

There are several types of products; how to choose:

For impeccable results, preferably use a combination of traditional products:

① **Washing detergent** to clean the crockery perfectly (powder, liquid or standard tablets).

② **Regenerating salt** to enable your dishwasher's water softener to operate correctly.

③ **Rinsing liquid** to assist drying and to eliminate marks from water droplets.

**Important:**

Never use washing-up liquid.

For ease of use and in certain water hardness conditions only (< 25°F), multi-purpose products can make the use of regenerating salt and rinsing liquid unnecessary.

- **"Two-in-one" tablets** contain detergents and rinsing liquid or an agent serving the function of the salt.

- **"Three-in-one" tablets** contain detergents and rinsing liquid as well as an agent serving the function of the salt.

- **"Four-in-one" "Five-in-one" tablets...** also contain additives that prevent wear on poor quality glasses or the risk of stainless items corroding.

**Important:**

Follow the instructions for using the multi-purpose product and the recommendations on the pack.

**NB:**

If in any doubt, please contact the detergent manufacturer if the crockery is very wet at the end of the programme or if chalky deposits appear.

EN 4/ WHAT TO DO BEFORE FIRST USING THE MACHINE

• MEASURE THE WATER HARDNESS AND SELECT THE TYPE OF DETERGENT: TRADITIONAL OR MULTI-PURPOSE

In one simple action, you can test the your water's lime content using the testing strip supplied with your dishwasher. Alternatively, contact your local water utility to ascertain your water's hardness.

- Let the water run from the tap for a few moments.
- Fill a glass with water.
- Take the test strip from its holder and immerse it for 3 seconds.
- Wait 1 minute, shake it and look at the colours to ascertain your water's hardness.



• HARDNESS TABLE

Test strip	□□□□□	■□□□□	■□□□□	■□□□□	■□□□□	■□□□□	■□□□□
Hardness	0-10°F	10-18°F	18-25°F	25-40°F	40-55°F	55-70°F	> 70°F
Water	Soft	Slightly hard	Slightly hard	Hard	Hard	Hard	Very hard
Water softening and use of salt	Optional	Essential if using traditional products	Essential if using traditional products	Mandatory	Mandatory	Mandatory	Mandatory

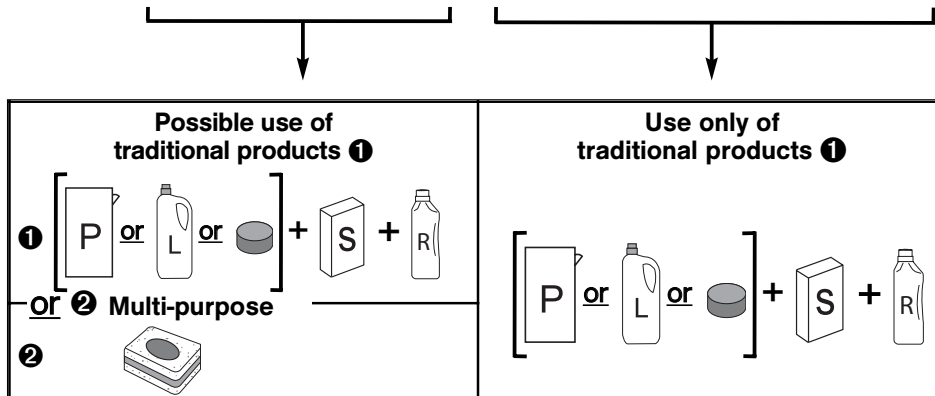

- ① **Traditional products:** P : Powder detergent or L : Liquid detergent or single tablet
+ S : Regenerating Salt + R : Rinsing product
- ② **Multi-purpose products:** Multi-purpose tablets

• **FOR TRADITIONAL PRODUCTS**

- *Your machine must be specially adjusted to use traditional products.*

• **Proceed as follows to set the softener on the control panel:**

- Turn the selector to the “Set” position; the screen displays **SEt** to inform you that you are in setting mode.
- Press the “Delayed start” button; the screen gives you the setting (**H4** factory setting).
- To change this setting (depending on hardness of water), press successively on the “Delayed start” button. Each press changes the setting. Refer to the table below.
- The setting is automatically confirmed when exiting Set; selector at programme or Stop position.

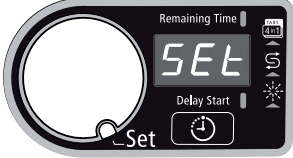

Testing strip							
Hardness	0-10°F	10-18°F	18-25°F	25-40°F	40-55°F	55-70°F	> 70°F
Traditional product	H0	H1	H2	H3	H4	H5	H6

⚠ Important:
It is very important to set the water softener correctly.
 - *If the setting is too low, there is the risk of chalky marks appearing.*
 - *If the setting is too high, there is the risk of causing clouding of the glasses.*
If you relocate, adjust the water softener setting as required.

• **Traditional tablets**
 Non-multipurpose tablets should be placed in the external compartment (Fig 04) or, for optimum performance, pull out the dispenser drawer and lay the tablet inside (Fig 05).

• **Powders or liquids (Fig 03)**
 Fill at least up to the minimum mark for slightly dirty crockery and to the maximum mark for dirty crockery. If the crockery is very dirty and for programmes with a pre-wash we recommend that you add 5g of detergent (a dessert spoonful) into your dishwasher’s tub in accordance with the programmes table.

⚠ Important:
Keep these products out of children’s reach and away from dampness.
Only use products specially designed for dishwashers.

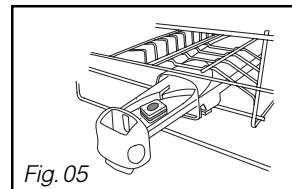
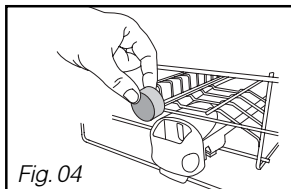
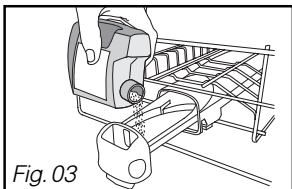



• **FOR MULTI-PURPOSE PRODUCTS :**  **OPTION**











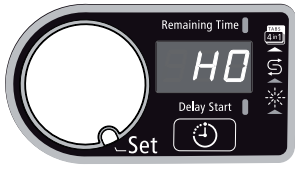











- Your machine can be specially adjusted to use multi-purpose products if the water hardness is less than 25°F.

 **Tip:** Your dishwasher's "TABS" option adjusts to the wide range of multipurpose products. It has two possible settings, which you access via the Select.

"Extra Dry" (the factory setting) improves the results after drying where the "2 in 1", "3 in 1" or "4 in 1" multipurpose product offers a lower level of performance.

"Sparkling Clean" improves the shine of your crockery, whatever sort of multipurpose product you use.

- **Proceed as follows to set the softener on the control panel:**
 - Turn the selector to the "Set", position; the screen display **SEL** to inform you that you are in setting mode.
 - Press the "Delayed start" button; the screen shows the setting (H¹ factory setting).
 - **To use the multi-function tablets, select the H0, H1 or H2 setting**, depending on the hardness of the water.
 - To change this setting (depending on hardness of water), press successively on the "Delayed start" button. Each press changes the setting.
 -  (Light unlit) : deactivates the "TABS" option.
 -  (Light permanently lit) : corresponds to activation of the "TABS" option with the "Extra Dry" setting.
 -  (Light flashing) : corresponds to activation of the "TABS" option with the "Sparkling Clean" setting.
 - The setting is automatically confirmed when exiting Set; selector at programme or Stop position.
 - The setting selected will be automatically applied; the "TABS" light will come on.

	Testing strip			
	Hardness	0-10°F	10-18°F	18-25°F
Multi-purpose products Function Deactivated	 	 	 	
Multi-purpose products Extra Dry	 	 	 	
Multi-purpose products Sparkling Clean	 	 	 	

 **Important :** The multi-purpose products setting enables you to deactivate the rinsing and salt warning lights only on H0 and "TABS".

• **Loading the multi-purpose tablet dispenser**

To assist in loading the detergent, the distributor is situated on the front of the upper basket. It is compatible with all the products recommended for dishwashers.

• **Place the tablet** in the external compartment (Fig 04 on previous page) or, for optimum results, pull out the distributor's drawer and lay the tablet inside (Fig 05 on previous page).

- Close the dispenser.

• **Loading of regenerating salt (Fig 06)**

Filling with salt is essential for providing a good wash without marks. It regenerates the resins that soften the water, by removing its lime content (unless the mains water supply is soft enough). Refer to “Setting the water softener”.

⚠ Important :
Only use special dishwasher regenerating salt. Do not use table salt or any type of cooking salt, this could damage your appliance's water softener.

- A** Unscrew and remove the stopper on the salt tank.
- B** Fill the tank with regenerating salt specially designed for dishwashers.
- C** Use the funnel supplied with your dishwasher. The first time, top up with water up to the rim of the tank.

• **Regenerating salt indicator:** 

This illuminates when salt must be added. After the tank has been filled with regenerating salt, the indicator light may remain lit until the salt has dissolved sufficiently, usually after one cycle (of if the tank has not been filled completely; for example, when first putting the machine into service using the sample).

This can be deactivated as indicated in the paragraph “For multi-purpose products” setting table.

⚠ Important
If the salt overflows when filling the tank, to avoid oxidization of the tub it is advisable to remove the salt crystals or to run a Prewash programme (or Rapid programme - depending on the model).

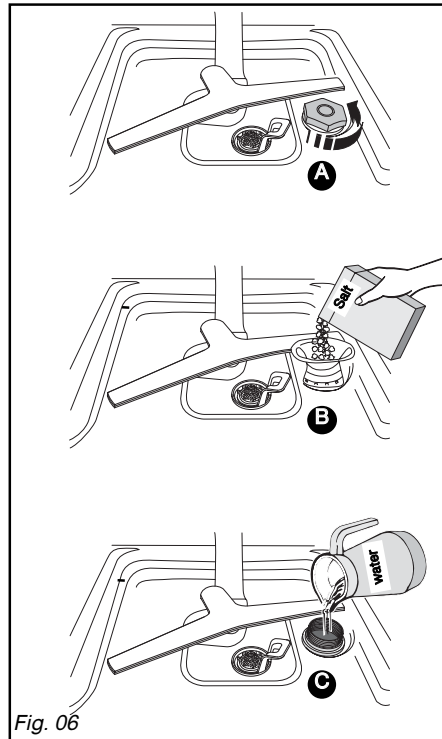

Fig. 06

• **Loading of rinsing product (Fig. 07)**

⚠ Important :
Only use a rinsing product designed for dishwashers. The rinsing product ensures your items shine and are well dried.

A B When first putting the machine into service, fill the tank until the level is flush with the top of the adjustment lever. Pour in at least all the rinsing product provided.
 The tank contains 120 ml (approximately one glass)

The original setting is in the centre (middle position: reference mark 2). If you encounter marks or poor drying after a few cycles, you can adjust the setting using the adjustment lever (fig 07 **C**); Reference mark 3 will increase the setting).

- Close the tank lightly

• **Rinsing liquid indicator light:** ✨

This illuminates when rinsing product is required.

It can be deactivated as shown in the paragraph "For multi-purpose products" setting table.

⚠ Important :
If any of the product overflows during filling, sponge up the excess to avoid producing foam.

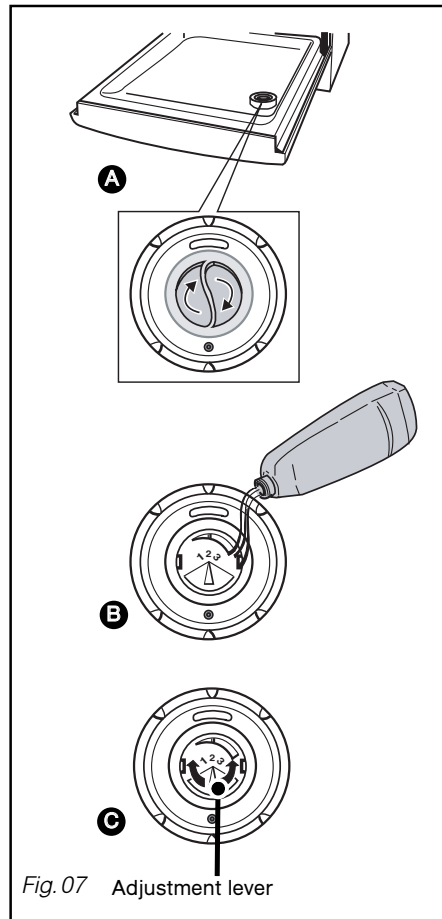



Very important

Items not suitable for washing in a dishwasher:

- *Wooden cutting boards*
- *Stainless steel utensils or plastic utensils that are not heat-resistant*
- *Copper or pewter items*
- *Glued crockery and cutlery*
- *Cutlery with wooden, horn or mother-of-pearl handles*
- *Antique or hand-painted porcelain*

When purchasing crockery, glasses or cutlery, ensure that it is dishwasher-safe

• THE LOWER BASKET

Arrange your items so that the water can circulate freely and spray over all the utensils. Place large diameter dishes and pans at the sides.

Do not intersperse, jam together or superimpose flat plates and concave dishes (Fig. 08). The flexible racking spikes makes it easier to arrange your large dishes (Fig. 09).



Advice:

When you re-insert the lower basket, ensure that nothing catches on the oversize plate barrier to avoid blocking the rotating spray arm.

Unloading your items

Empty the lower basket to avoid drips from the upper basket falling onto the lower basket.

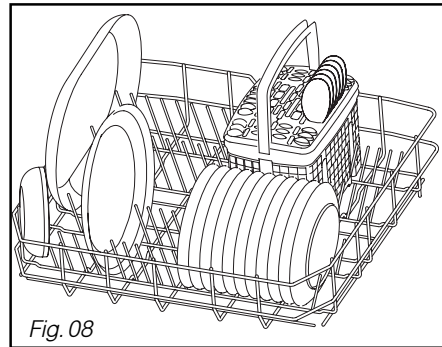

Fig. 08

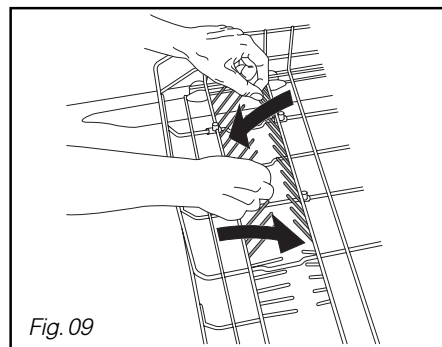

Fig. 09

• **THE UPPER BASKET**

This basket is particularly designed to take glasses, cups, ramekins, small salad bowls, bowls and saucers.

Arrange your items methodically to save on space (arranging glasses, cups or bowls together).

You can also arrange cups, ladles, etc. on the folding cup racks (Fig. 10)



Advice:
Position the cavities of glasses, cups or bowls facing downwards.

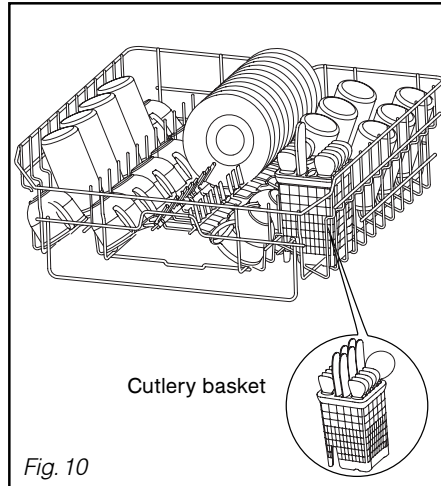

Fig. 10

• **Adjusting the height of the upper basket**

For large dishes to be loaded in the lower basket, the upper basket must be set to the high position. This can be done with the basket fully loaded (Fig. 11)

① **Setting in HIGH POSITION:**

Gently raise your basket on each side until it engages.

② **Setting in LOW POSITION:**

Raise your basket completely on both sides to unlock it and then lower it to the low position.

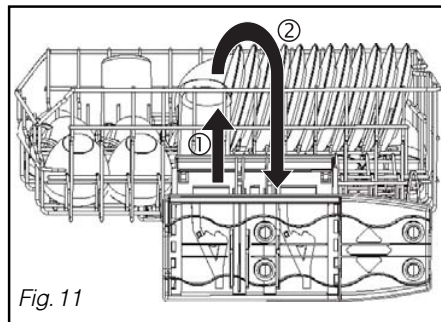

Fig. 11



Important :
Check that the two slides are set to the same height and the basket is horizontal.

• **THE CUTLERY BASKET**

The cutlery basket slides to allow flexible loading.

It can be placed anywhere in the lower basket. You can therefore make a variety of loads depending on the items (Fig. 12).

If your cutlery items or your dishes are too large, alter the height setting for the upper basket.

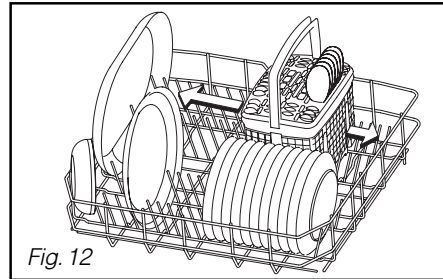

Fig. 12

Movable grills are available for if you wish to load your cutlery in an orderly manner (Fig. 13).

For optimum washing and drying, use these separation grills partially or totally.

Point the handles on the cutlery downwards.

⚠ Important :
For safety reasons, we recommend that you place knives with pointed ends with the point facing downwards in the cutlery basket (to avoid the risk of an accident). Long-bladed knives and other sharp kitchen utensils must be placed flat in the upper basket.

Avoid washing cutlery with horn handles in your dishwasher.
Separate silverware from other metals using the separation grill.

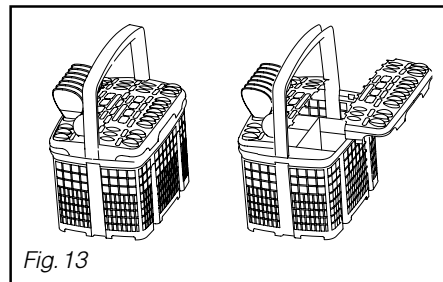

Fig. 13

- ***Door not closed properly***

The screen flashes when the door is not closed or not properly closed.

- ***Locked programme access***

While the programme is running, the programme selection switch is automatically locked and cannot be changed. It will unlock automatically when the programme ends or is cancelled.

- ***Anti-overflow system***

This system automatically activates the drain pump if the water level in the tub reaches an abnormal height.

- ***Anti-leak system***

This system interrupts the water supply if a leak is detected under the appliance.



Note:

To unlock, press the Start/Cancel button and hold it down for three seconds.

• PROGRAMMES TABLE

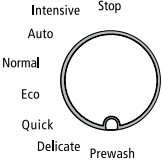
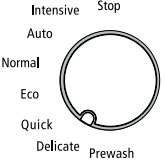
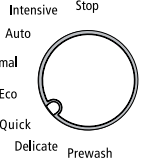
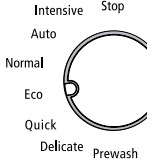
Type of items: - porcelain, pans, cutlery, glasses, etc. Quantity, type and amount of food residue.	Mixed	Delicate	Mixed	
	Very short cycle (with no detergent) for rinsing and re-dampening the items while waiting for a wash expected the following day or even the day after 	For glasses and delicate crockery Meaning a smaller quantity of not very sticky residues. 	Very short 30-minute wash specially designed for a small amount of daily items with a limited amount of non-greasy residue, not dried on 	
PROGRAMMES	Prewash	DELICATE	QUICK	
Programme sequence	Cold pre-wash	Washing at 40°C Rinse Hot rinse Drying by condenser	Washing at 45°C Rinse Hot rinse Short drying cycle, not fan assisted	
As an indication only:				
Duration in min	15'	60' - 75'	30'	
Water (L)	4,5	16	11	
Energy (Kwh)	0,02	0,95	0,8	

These values refer:

- to normal usage conditions with separated products (detergents, salt, rinsing product).

- only to multifunction product usage conditions

They may vary depending on the load, the water temperature, the softener setting, the presence of rinsing product and the supply voltage.

EN 10/ WASHING PROGRAMMES

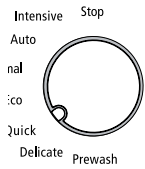

Mixed	Mixed	Mixed	Resistant
<p>Normally dirty, i.e. a normal amount of sticky and greasy residue. A longer programme because it saves on energy.</p>	<p>Normally dirty, i.e. a normal amount of sticky and greasy residue.</p>	<p>Automatic detection of the amount of residue. Optimises the results and prioritises energy savings.</p>	<p>Very dirty large dishes and pans, with baked on residue, grease, cooked cheese, sauce, etc.</p>
Eco	Normal	Auto	Intensive
		Pre-wash	Hot pre-wash
Washing at 50°C	Washing at 60°C	lavage 55/65°C	Washing at 70°C
Rinse	Rinse	Rinse	Rinse
Hot rinse	Hot rinse	Hot rinse	Hot rinse
Drying by condenser	Drying by condenser	Drying by condenser	Drying by condenser
160' - 165' 16 - 18 1,05 - 1,3	60' 16 1,3 - 1,4	100' - 130' 17 - 21 1,4 - 1,6	120' - 140' 17 - 19 1,7 - 1,8

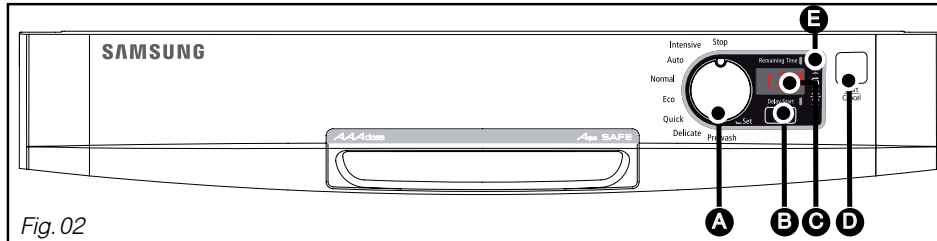

Fig. 02

Advice : Consult the Programmes table on the preceding pages to determine the programme you need for the type of items, the quantity and the amount of food residue.

• **Immediate start of a programme**

Choose the programme by turning Selector **A**. The screen displays the duration of the programme selected.

Press “**Start**” **D**, and the programme begins.

The “Time remaining” light comes on.

The screen tells you the time remaining for the programme as the programme progresses.

Programme length



Remaining time



End of programme



• **Delayed start of a programme.**

Programme delayed start, one hour at a time (1 hr to 12 hrs), by pressing the “**Delayed start**” button.

Confirm by pressing **D**. “**Start**”.

The screen counts down the time until the programme starts.

Waiting for delayed start



Remaining time



End of programme



• **Cancelling a programme.**

Press the **D** “**Cancel Start**” button for a few seconds. The “Time remaining” light is off; you may re-programme.

• **Stopping the machine.**

When the programme has finished, turn the selector to **A** “**Stop**” position.

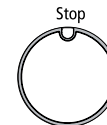

• **CLEANING THE WASTE FILTERS**

The filtration system consists of several elements:

- Ⓐ - The waste filter
- Ⓑ - The large main filter
- Ⓒ - The micro filter

The filters are located in the centre of the tub and must be washed regularly to obtain optimum washing results.

Actions :

- ① Before removing the filters, remove any waste on the large main filter Ⓑ with a sponge so that the waste does not block the sprinkler arms. Rotate the spray arm as shown in the drawing. (Fig. 14)
- ② Loosen the waste filter a quarter of a turn and then remove it Ⓐ
- ③ Remove the main filter Ⓑ
- ④ Remove the micro filter Ⓒ

- ⑤ Carefully clean filters Ⓐ, Ⓑ and Ⓒ under running water (Fig. 15)

Re-installation:

Proceed in reverse order, inserting filters Ⓒ and Ⓑ and then Ⓐ



Important :

Remember to lock the waste filter Ⓐ in place by pushing it in fully and turning it a quarter turn.

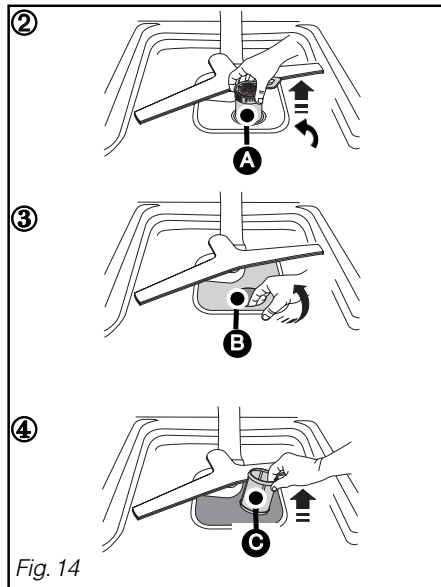
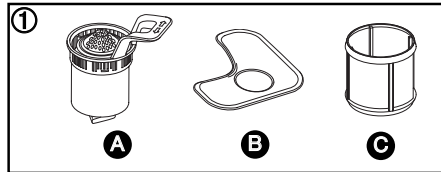

Fig. 14

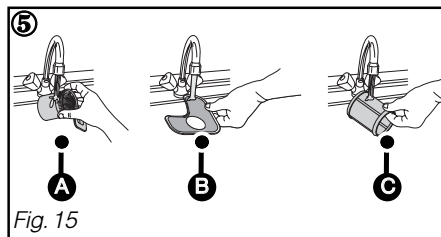

Fig. 15

- **Periodically**

Every 3 or 4 months, in order to remove any deposits, run a special maintenance programme, without any items in the machine, using a special dishwasher cleaning product.

Important :

Keep this product out of children's reach.

- **If not using your dishwasher for a prolonged period:**

Clean your dishwasher completely and then unplug it from the electricity supply and close the water tap. Protect your machine from potential frost.



Advice :

Do not use abrasive powders, metal sponges and alcohol-based or thinner-based products. Use a cloth or a sponge.

If you are moving house, run a soaking programme first of all, in order to avoid any water escaping.

• **SUMMARY OF THE FAULTS**

d01: water supply fault (tap)	d07: overflow / anti-leak fault
d02: draining fault	d08: sprinkling distribution fault
d03: heating fault	d11: pressure sensor fault
d04: temperature fault	d12: filling fault (water inlet detection system)
d05: fault – motor under load	d13: overheating fault
d06: fault - motor overload	d14 : installation fault : (incorrect drainage connection or inadequate flow rate and tap).



Tip:

If one of the above faults occurs and you need to call a repair man, remember to tell him the message displayed (d01, d02..) as this information will help him.

• **BEFORE CALLING FOR SERVICE**

Problem	Possible causes	What to do?
The door falls heavily when opened (integratable model)	- Door springs not tensioned enough to compensate for the weight of the panel.	- Tighten the two tensioning screws accessible in the bottom section above the front feet.
The door does not stay horizontal when open or returns too quickly (integratable model)	- Door springs tensioned too much. - No wooden panel.	- Loosen the two tensioning screws accessible in the bottom section above the front feet. - Fit a temporary wooden panel on the appliance and adjust the springs.
The door catches when closing	- Appliance not stable - Door not centred on the tub	- Adjust the feet. - Re-centre by adjusting the rear feet.
The upper basket does not stay in the high position	- Poor manipulation (the basket is being pulled upwards too quickly)	- Act more progressively (see instructions), one side and then the other.
Small leak around or under the appliance (move the appliance to locate the leak)	- Leak from the tap. - Leak from the appliance. (Cf. table fault d07).	- Check that a seal is fitted and retighten the nut. - Close the water tap and call a technician.
Small leak at the door	- Appliance not stable or not level - Door not centred on the tub.	- Adjust the feet. - Re-centre by adjusting the rear feet.

• **THE INDICATOR LIGHTS**

Problem	Possible causes	What to do?
The salt light does not go out	- No salt or an insufficient quantity of salt in the tank to trigger the float.	- Refill the tank and wait for the cycle to end. If you have soft water that requires no salt, the light is constantly lit.
The lights all light up one after the other	- Wrong programme.	- Cancel the current programming by holding down the Start button for 3 seconds and then re-programme.
A light flashes and the programme does not start	- Programme selector wrongly positioned (between two notches)	- Reposition the selector on a programme.

• **RELATING TO PROGRAMMING, DISPLAY**

Problem	Possible causes	What to do?
The cycle lasts too long	- The energy-saving programmes last longer because the agitation and drying times are longer to compensate for the lower washing and drying temperatures	- Use these programmes preferably at night when it is not so important how long the programme lasts or when it ends.
The appliance trips the circuit breaker	- Insufficient amperage to supply all the appliances being operated simultaneously. - Internal fault in the appliance.	- Check the socket's amperage (10A minimum) and the meter's capacity. - Call a technician.
The appliance does not start	- No mains power to the socket. - Tap closed (Cf. table fault d01). - Water supply hose kinked. - Selection error or programme blocked. - Start button pressed too long (greater than 2 secs). - Appliance in Safety mode (anti-leak) (Cf. table fault d07).	- Check the socket and the fuse - Check the tap is open. - Check the hose line is OK. - Cancel by holding down Start for 3 secs and re-programme. - Just press Start briefly to start the programme. - Call a technician.

EN 13/ IF OPERATING ABNORMALITIES OCCUR

Problem	Possible causes	What to do?
The appliance will not restart	- Door opened during a washing cycle.	- Wait for the time delay to end (controlled internally by the appliance).
The appliance does not drain (Cf. table fault d02).	- The cover has not been removed from the sink's U-bend. - Drain hose kinked. - Filters totally blocked. - Pump blocked.	- Remove the cover. - Check the drain hose line behind the machine is OK. - Remove and clean the filters and the drain. - Initiate a Soaking programme If the fault persists, call a technician.
The appliance will no longer function (see table, fault 14).	- installation of non-compliant drainage system: drainage too low down or pipe pushed too far in. - siphoning: the appliance is emptying as the same time as it is filling up.	- adhere to the drainage tube installation dimensions.

• POOR WASHING RESULTS

Problem	Possible causes	What to do?
Food traces and deposits in the glasses	- Items poorly arranged (masked by another larger item or situated underneath it, items nested or jammed together). - Upper spray arm blocked by cutlery or a dish etc. - Filter poorly locked and lifting during washing. - Micro filter screen clogged. - One or more holes in the spray arm blocked.	- Arrange the items properly. Use the most appropriate areas and accessories for each type of item (see instructions). - Check that the spray arm rotates freely. Set the basket in the high position if necessary. - Check the filter's facing and that the filter is locked in place (push it in fully, turning it to the right). - Remove all the filters and clean them (in warm water), including the micro filter's screen (once a month). - Remove the spray arm by turning the lever a quarter of a turn and clean it under the tap (do not use any tool that could damage the holes). Re-install the spray arm.
Traces of grease	- Detergent dose too low; inefficient detergent; stale product. - Inappropriate programme (temperature too low; duration too short).	- Increase the dose; try another detergent. - Select a programme with a higher temperature.

• **POOR WASHING RESULTS...**

Problem	Possible causes	What to do?
White marks (identify what type)	<ul style="list-style-type: none"> - Chalky film (removable with vinegar). - Traces of salt (items have a salty taste). 	<ul style="list-style-type: none"> - Check that there is salt in the tank (light unlit = OK). - Check the water hardness at the tap and that the water softener is set correctly. Adjust it to a higher level if necessary. - Water too hard for using a "4-in-1" detergent without the addition of salt. - Check that the stopper on the salt container is closed correctly.
White marks (identify what type)	<ul style="list-style-type: none"> - Glass cloudy because water too soft (cannot be removed). 	<ul style="list-style-type: none"> - Check the water hardness at the tap and that the water softener is set correctly. Some detergents in pellet form are more aggressive to glasses and decorations (change the product and use a protective product if necessary).
Coloured marks (tea, wine, coffee)	<ul style="list-style-type: none"> - Items poorly arranged - Detergent dose too low; inefficient detergent - Programme temperature too low. - If you use a multifunction product. 	<ul style="list-style-type: none"> - Turn the cavities in the items towards the jets. - Increase the dose; try another detergent. - Select a more suitable programme with a higher temperature. - Use the "4-in-1" option (depending on the model).
Streaks or dried droplets on glasses	<ul style="list-style-type: none"> - Lack or insufficient amount of rinsing product. - Rinsing product out-of-date or inefficient. - If you use a multifunction product. 	<ul style="list-style-type: none"> - Check the indicator light and fill the tank completely. Adjust the dispensing unit to a higher position if necessary. - Use a recent product (a good product dilutes easily and foams in cold water). - Use the "4-in-1" option with a setting prioritizing drying (parametering from the menu – depending on the model).
Dried-on marks on glasses, dullness.	<ul style="list-style-type: none"> - If you use a multifunction product. 	<ul style="list-style-type: none"> - Use the "4-in-1" option with a setting prioritizing brilliance (parametering from the menu – depending on the model).

• **POOR OPERATION**

Problem	Possible causes	What to do?
Constant filling A lot of waste on the large filter at the end of the cycle.	- Drain hole situated too low for the appliance (Cf. table fault d012). - The filters and drain outlets are blocked with too much residue.	- Drain wand has fallen on the floor. - Remove and clean the filters and the bottom of the drain outlets. Remove large residue from the plates before putting them in the machine.
Traces of rust on stainless steel	- Quality of the stainless steel ; not dishwasher-safe (knives in particular)	- Use "special dishwasher-safe" cutlery. - Check that the lid on the salt container is closed correctly.

• **POOR DRYING RESULTS**

Problem	Possible causes	What to do?
A lot of droplets on the glasses	- Lack or insufficient amount of rinsing product. - The dose has not been distributed. - Positioning of the items.	- Check the indicator light and fill the tank completely. - If the tank is not empty after approximately 60 washings, call a technician. - Arrange the items to restrict water retention as much as possible. Leave the door ajar for a few minutes, if possible
Droplets on plastic items, Tefal coatings, etc.	- These items have a low caloric mass.	- Arrange the items in the upper basket.
Poorer drying on rapid programmes	- On rapid programmes, the drying temperature and drying period are reduced to cut down the duration of the cycle as much as possible.	- Leave the door ajar for a few minutes.
Condensation on the wall of the inside door or the tub.	- Condensation may form on the walls, particularly after the appliance has cooled down (sound insulation increases this occurrence)	

• **INTERVENTION WORK**

Any intervention work on your appliance must be performed by a qualified professional approved by the manufacturer. When you call, please mention the full reference for your appliance (model, type and serial number). This information is shown on the description plate (see Fig. 16)

ORIGINAL PARTS

When maintenance is being carried out, ask for only certified original spare parts to be used.

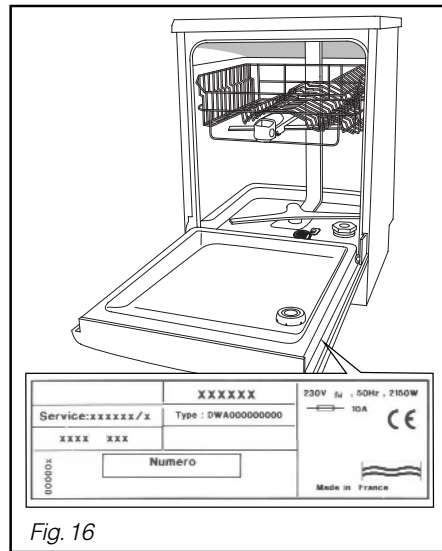

Fig. 16

• **Details common to all models**

- Washing capacity ----- 12 standard place settings
- Arrangement of the items ----- Figs. A-B-C; see next page
- Loading as per the indications on next page, without side shelves
or stemmed glass support, and 5 cup/saucer supports
(4 for 12 saucers & 1 for 2 cups)
- Setting for upper basket ----- Low position
- Setting for rinsing product distributor ----- 3
- Adjusting the water softener ----- H2

For detailed information on the comparison tests regarding the level of soiling, the types of crockery and cutlery, etc., contact the equipment manufacturer before commencing the tests.

• **Tests to Standard EN 50242:**

- Recommended programme ----- "Eco"
- Dosage of detergent ----- 30 g of detergent B

NB: When conducting tests using a multi-function tablet: H0 or H1 or H2

- Check that the water softener is correctly set for the water hardness
- Pull out the detergent distribution drawer and place the tablet in the interior compartment.

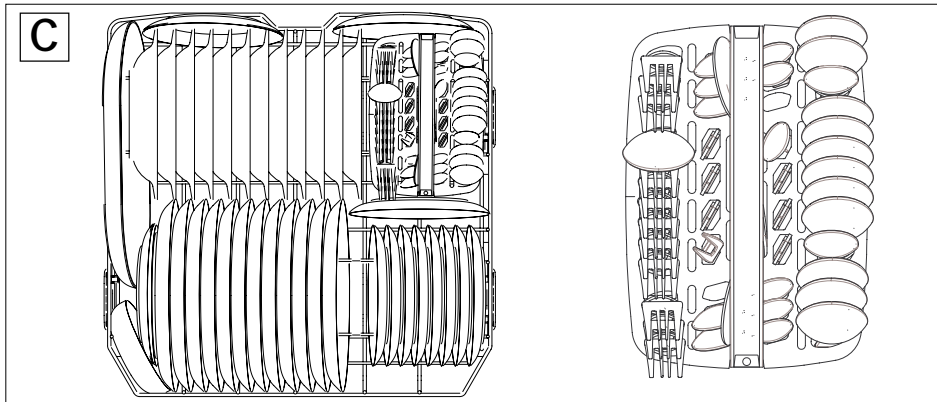
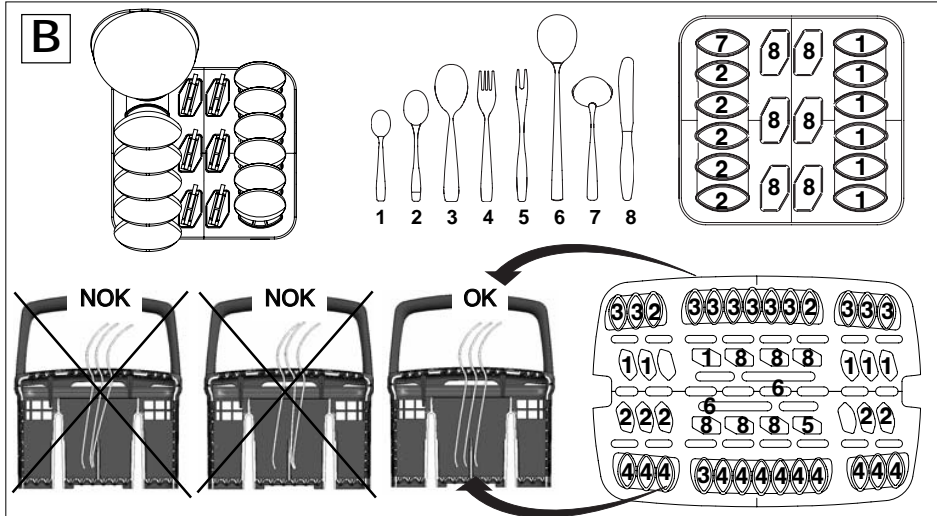
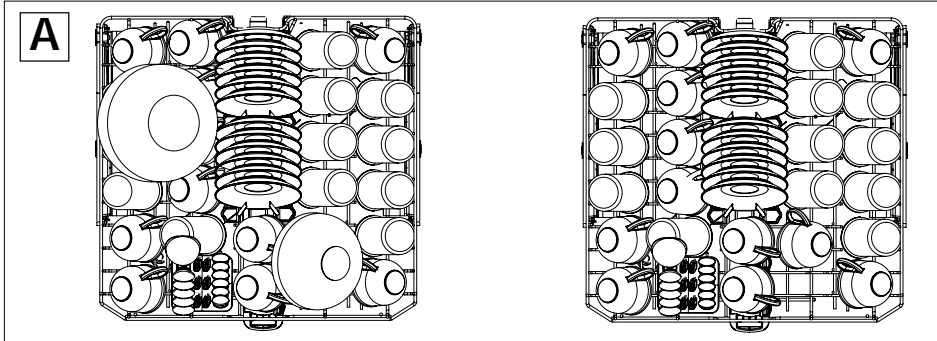



Contact SAMSUNG WORLD WIDE

If you have any questions or comments relating to Samsung products, please contact the SAMSUNG customer care centre.